



ELGIN & HALL[®]

BRITISH MADE



HEATING HOMES FOR GENERATIONS



Welcome

An Elgin & Hall fireplace could easily be the most rewarding addition you make to your home and its value. Since the foundation of our parent company in 1963, we have successfully continued to grow from our base in the North East of England. Every design is lovingly created here in the UK.

Over 56 years of continuous innovation and development has provided us with a collection of fires and fireplaces to suit any interior and lifestyle, whilst always adhering to our founding principles of elegance and simplicity. This timeless quality means your chosen fireplace will always be comfortably in agreement with your tastes in furnishing and décor.

You can rest assured that our gas and electric fires are engineered, produced and tested for peak performance and reliability.

Our surrounds are designed to keep up with changing lifestyles and include features which only we can produce thanks to our investment in the latest machinery.

At the same time, we depend on our craft skills to hand finish and polish each marble, limestone or timber piece to perfection. It is this balance of innovation and heritage that makes your Elgin & Hall fireplace uniquely special.

As part of the BeModern® Group we manufacture a range of product in house, to include, surrounds, fires and fireplaces in marble, limestone and timber, as well as steel and cast stoves. Our bathroom range suits both the traditional and contemporary home.



Our Commitment

Highest Standards of Quality BeModern® furniture suppliers manufacture a world class product and continuous investment means we are recognised as the industry leader:

- Operating to ISO 9001:2015 accreditation
- Working closely with our supply partners to maintain the highest quality of raw materials.
- Investing in new technologies to provide innovative solutions.

Our CSR Policies

We are aware that global climate change threatens the wellbeing of the natural environment and society. Whilst governments around the world move to agree on cutting greenhouse emissions, as a British manufacturer BeModern® works to minimise our own carbon footprint, cut emissions, reduce waste, recycle and reap the benefits of new, green ways of running a manufacturing business.

Responsible Manufacturing

We are dedicated to minimising the environmental impacts of our manufacturing activities and seek to explore new ideas through eco innovation, for example our 2010 investment of over £1m in an eco-boiler to convert all waste timber into heat for our factories.

Environmental Management

Having been accredited with ISO 14001:2015, the internationally recognised environmental management standard, BeModern® is committed to continually improving the effectiveness of our environmental management system.

Transport

BeModern® logistics department makes thousands of deliveries each year, providing us with an opportunity to reduce the carbon footprint through regularly modernising our fleet to minimise noise and air pollution and training drivers in fuel efficient, safe driving.

FSC® Timber

Wood is a significant material used across many BeModern® products. As demand for forestry products continues to grow, BeModern® plays its part in conservation by selecting over 75% of its raw timber from well-managed FSC® (Forest Stewardship Council®) recognised forests and holds full Forest Stewardship Council chain of custody certification.





1964



2021

Our history so far



1963

Business starts as **Modern Trends** manufacturing fire surrounds in Hendon, Sunderland from a 5000sq.ft factory



1964

Business incorporated as BeModern®



1967

Expansion of BeModern® leads them to move to larger premises in Nile Street, South Shields



1970

Continued expansion leads to purpose built premises in Western Approach, South Shields



1982

BeModern® moves into the retail sector with the acquisition of Academy Crafts selling kitchen furniture



1988

BeModern® celebrates 25 years as a British manufacturer



2001

BeModern® acquires current Shaftsbury Avenue site and commences manufacture of marble surrounds (later extended in 2004 & 2013)



2006

BeModern® acquired design and product rights of **Elgin & Hall** - manufacturing hand painted, individually crafted fire surrounds in our Marcraft factory



2009

BeModern® acquires **Broseley** in Shropshire, to extend product choice into multifuel, woodburning, electric and gas stoves (later moved to Jarrow Head Office 2019)



2012

Broseley Stoves now manufactured at our Shaftsbury Avenue site



2013

BeModern® celebrates 50 years as a British manufacturer



2014

BeModern® headquarters move from Western Approach in South Shields after 44 years to Bedesway Jarrow after a major £1m makeover



2018

Elgin & Hall's Pryzm range is developed and released



2019

BeModern® successfully exhibit at the Hearth & Home show with a vast range of new product



2020

Elgin & Hall will continue to develop first class product and remain at the forefront of the fireplace industry



2021

Pryzm range is developed further and the Arleon fire range is released

Micro Marble Surrounds

Micro marble is a reconstituted mix of real marble pieces which are crushed and compacted together using resin to ensure a smooth surface finish.

This beautiful material has to be seen to be believed and to be fully appreciated first hand. The craftsmanship we devote to producing fireplaces in our UK workshops is matched by innovation.

Contents

Roesia.....	7
Elento	8
Mosello	9
Amorina	10
Vitalia	11
Odella	12
Odella Inglenook	13
Verdena.....	14
Viena.....	15
Eliana.....	16
Sophia	17
Florano	18
Timara.....	19

Hearth Options



- SL
- Standard Lipped
- BN
- Bullnose
- FS
- Five Sided



BESPOKE SIZES
Ask your local retailer for more information.

Optional Lighting

Smartsense Undermantel LED lighting is available on all our marble surrounds.



Finishes

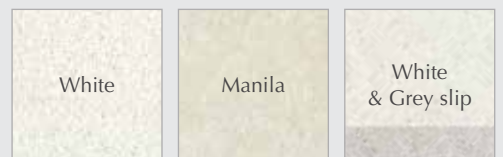

Our micro marble is available in 3 stunning finishes, Manila, White and White with a Grey slip.

Roesia

Micro Marble Surround

50" Roesia surround in White micro marble with Smartsense LED lights featuring a small Beacon inset electric stove



SL FS BN



W1120mm
44" H1085mm
D400mm

W1270mm
50" H1145mm
D400mm

Rebate
45mm / 75mm

Back Panel cut out
16" / 22"*



White

*22" cut out not available on 44" model

Elento

Micro Marble Surround

52" Elento surround in White & Grey slip micro marble with Smartsense LED lights featuring a large Beacon inset electric stove



W1220mm
48" H1115mm
D400mm

W1320mm
52" H1115mm
D400mm

Rebate
45mm / 75mm

Back Panel cut out
16" / 22"*

White
& Grey slip

Mosello

Micro Marble Surround

52" Mosello surround in White & Grey slip micro marble with Smartsense LED lights featuring a 16" Chollerton gas fire in Black Nickel



SL



EEC: C

W1220mm
48" H1115mm
D400mm

W1320mm
52" H1115mm
D400mm

Rebate
45mm / 75mm

Back Panel cut out
16" / 22"*



White
& Grey slip

*22" cut out for Chollerton gas is not available on 48" model (Only electric is compatible)

Amorina

Micro Marble Surround

50" Amorina surround in White micro marble with Smartsense LED lights featuring a 16" Pryzm inset electric fire with Devotion fascia in Brushed Steel



P R Z M
REVOLUTIONIZING FLAMES

50" W1270mm
H1137mm
D400mm

Rebate
45mm / 75mm

Back Panel cut out
16" / 22"

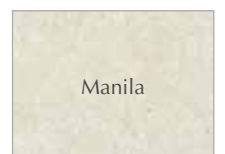

Vitalia

Micro Marble Surround

52" Vitalia surround in White micro marble with Smartsense LED lights featuring a 22" Chollerton gas fire in Black Nickel



SL FS BN



EEC: C

W1220mm
48" H1080mm
D400mm

W1320mm
52" H1040mm
D400mm

Rebate
45mm / 75mm

Back Panel cut out
16" / 22"*

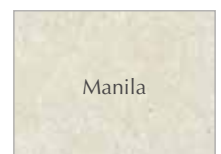

*22" cut out for Chollerton gas is not available on 48" model (Only electric is compatible)

Odella

— Micro Marble Surround & Inglenook —

54" Odella surround in White micro marble with Smartsense LED lights featuring a 16" Mid-Depth HE Inset Gas fire (Top). Also shown with a 16" Chollerton Gas fire (Bottom)



SL



White micro marble surround (H1235mm)

EEC: D



SL



White micro marble surround (H1160mm)

EEC: C

W1370mm
54" H1160mm
D400mm

W1370mm
54" H1235mm
D400mm

Rebate
75mm

Back Panel cut out
16" / 22"



White

Odella

Micro Marble Inglebrook

54" Odella Inglebrook in White micro marble with Smartsense LED lights featuring a Heslington electric stove in Matt Black



SL



Shown with Heslington Electric Stove by Evolution

54" W1370mm
H1235mm
D400mm

Rebate
75mm

Inglebrook Rear Hearth:
W1016mm
H20mm
D457mm

Inside Leg Opening
Width: 856mm

Opening Height:
908mm

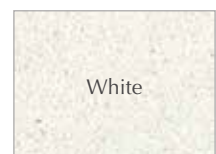

White

Verdena

Micro Marble Surround

54" Verdena surround in White micro marble with Smartsense LED lights featuring a Classic Devotion Hampden gas fire in Black Nickel



EEC: F

W1220mm
48" H1110mm
D400mm

W1370mm
54" H1110mm
D400mm

Rebate
45mm / 75mm

Back Panel cut out
16" / 22"*



White

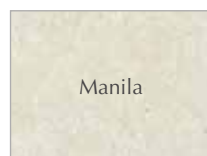

Manila

Viena

Micro Marble Surround

48" Viena surround in White micro marble with Smartsense LED lights featuring the 16" Chollerton electric fire in Chrome



W1220mm
48" H1110mm
D400mm

W1370mm
54" H1110mm
D400mm

Rebate
45mm / 75mm

Back Panel cut out
16" / 22"*



White

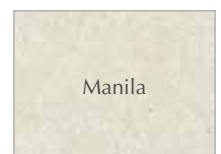

Manila

*22" cut out is not available on 48" model

Eliana

Micro Marble Surround

52" Eliana surround in Manila micro marble with Smartsense LED lights featuring an Eclipsim gas fire in Matt Black with polished detail



SL

FS

BN



EEC: C

W1220mm
48" H1155mm
D400mm

W1320mm
52" H1155mm
D400mm

Rebate
45mm / 75mm

Back Panel cut out
16" / 22"*

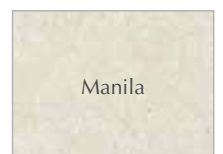

White

Manila

Sophia

Micro Marble Surround

50" Sophia surround in Manila micro marble with Smartsense LED lights featuring a 16" Devotion gas fire in Black Nickel



SL FS BN



EEC: D

W1170mm
46" H1085mm
D400mm

W1270mm
50" H1145mm
D400mm

Rebate
45mm / 75mm

Back Panel cut out
16" / 22"*



White

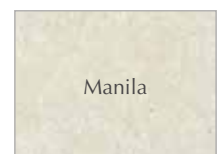

Manila

*22" cut out is not available on 46" model

Florano

Micro Marble Surround

48" Florano surround in White micro marble with Smartsense LED lights featuring a 16" Pryzm electric fire with an Edge Black Nickel trim



P R Z M
REVOLUTIONIZING FLAMES

W1070mm
42" H1050mm
D400mm

W1220mm
48" H1095mm
D400mm

Rebate
45mm / 75mm

Back Panel cut out
16"



Timara

Micro Marble Surround

48" Timara surround in White & Grey slip micro marble with Smartsense LED lights featuring a 16" Chollerton gas fire in Black Nickel



EEC: C

W1070mm
42" H1050mm
D400mm

W1220mm
48" H1095mm
D400mm

Rebate
45mm / 75mm

Back Panel cut out
16"



White



White
& Grey slip

*SL available on 42" & 48". BN, FS available on 48" only

Limestone Surrounds

To create a graceful Limestone centrepiece, the quarried stone is expertly selected, cut, carved and smoothed to give your room a splendid feature. Limestone has been sought after down the ages due to its adaptability.

Our Limestone surrounds are manufactured from natural stone resulting in natural variation; this can include shading, veining, crystal markings and fossils. Therefore the Limestone surround you purchase may differ slightly from that shown in this brochure and have its own unique markings. This is the beauty of a natural stone product.

Contents

Colwyn.....	21
Vitalia.....	22
Aurelia.....	23

Hearth Options



SL

Standard Lipped

BV

Bevelled Deep

Lighting

Smartsense Undermantel lighting is standard on all our Limestone surrounds.



Caring for Limestone

Limestone needs special care and attention. It can stain and is sensitive to acids such as citrus juice, vinegar and household cleaning chemicals.

- Use a mild, neutral cleaner
- Avoid chemical cleaners, wax or polish
- Simply clean with warm water

Colwyn

Limestone Surround

54" Colwyn surround in Limestone with Smartsense LED lights featuring a 16" inset gas fire with Cast Stove front in Matt Black



BV



EEC: D

54"
W1370mm
H1170mm
D400mm

Rebate
25mm

Back Panel cut out
16"

Also available as a
surround only
(no back panel
or hearth)

Limestone

Vitalia

— Limestone Surround —

52" Vitalia surround in Limestone with Smartsense LED lights featuring a 22" Chollerton inset gas fire in Chrome



SL



EEC: C

52" W1320mm
H1035mm
D400mm

Rebate
75mm

Back Panel cut out
16" / 22"

Limestone

Aurelia

Limestone Surround

48" Aurelia surround in Limestone with Smartsense LED lights featuring a 16" Chollerton gas fire in Black Nickel



SL



EEC: C

48" W1220mm
H1105mm
D400mm

Rebate
75mm

Back Panel cut out
16"

Limestone

Micro Marble Gas Fireplaces

Pre-Cast or Standard flue solutions

We have engineered a way to fit our highly desirable gas fires into the standard 16 x 22" opening in a UK chimney breast or pre-cast flue, with no building work.

Whichever you prefer, the installation is all the more simple because all the fireplaces are made as a complete single unit. It has taken years of research to develop and perfect this innovative technology which puts Elgin & Hall a step ahead of the market.

Contents

Adele.....	25
Vitalia.....	26
Embleton.....	27
Wayland.....	28
Cassius.....	29
Mariella.....	30
Orieta.....	30
Earlston.....	31

Flue Fit Options

Standard



Conventional
Class 1

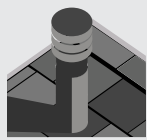

Conventional
Class 2

Pre-Cast

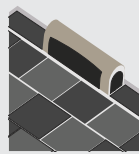

Pre-Cast Flues

Finishes

White

Manila

White
& Grey slip

Smartslide Control



Super Controllable
see page 53

Elsie 900 & 950 - Easy installation guide (see pages 26-31)

Easy installation with
a Pre-cast & Brick
Chimney (900)

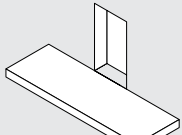

Pre-cast/ Class 1
flue opening

STEP 1

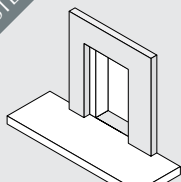

Pre-cast Spacer Frame
(Not applicable to Class 1 flue)

STEP 2

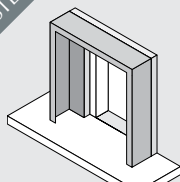

Fixing Plate

STEP 3

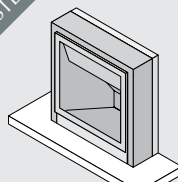

900 gas fire

STEP 4

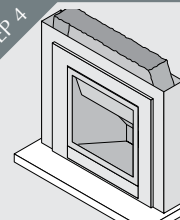

Marble Surround

STEP 5

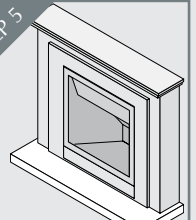

Shelf,
sit back and relax

NEW

Adele

800CF Micro Marble Gas Fireplace

The Adele micro marble fireplace is designed for the Calleos 800CF Gas fire and is suitable for both conventional class 1 and class 2 flues. A unique dual gas burner creates a truly mesmerising flame pattern



SL



Shown with included Slim Trim

EEC: E



SL



Shown with optional Wide Trim

EEC: E

W1370mm
H875mm
D300mm

Flue Fit Options	
Standard	
Conventional Class 1	Conventional Class 2

Heat Output
2.9 / 4.4kW

Non Reflective Glass available as optional extra

Wide Trim available as optional extra

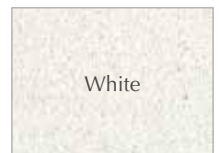

White

Vitalia

48" Vitalia gas fireplace in Manila micro marble complete with 900 gas fire

Micro Marble Gas Fireplace



SL



EEC: D

W1220mm
48" H1080mm
D400mm

W1320mm
52" H1150mm
D400mm

Flue Fit Options
Standard
Conventional Class 1 | Conventional Class 2

Pre-Cast
Pre-Cast*

Heat Output
5.1kW



White

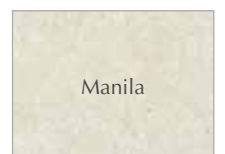

Manila

Embleton

Micro Marble Gas Fireplace

52" Embleton gas fireplace in White & Grey slip micro marble complete with 900 gas fire



SL



EEC: D

W1320mm
H1159mm
D400mm

Flue Fit Options	
Standard	
Conventional Class 1	Conventional Class 2

Pre-Cast
Pre-Cast*

Heat Output
5.1kW

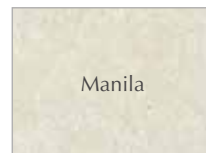

*For pre-cast model, please state when ordering.

Wayland

Micro Marble Gas Fireplace

52" Wayland gas fireplace in Manila micro marble complete with 950 widescreen gas fire



EEC: E

W1320mm
52" H947mm
D400mm

Flue Fit Options		Pre-Cast Pre-Cast*
Standard	Standard	
Conventional Class 1	Conventional Class 2	

Heat Output
4.6kW



White

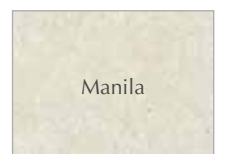

Manila

Cassius

Micro Marble Gas Fireplace

52" Cassius gas fireplace in White & Grey slip micro marble complete with 950 widescreen gas fire



EEC: E

AWARD WINNER
BEST GAS SUITE &
PRODUCT OF THE YEAR



W1320mm
52" H967mm
D400mm

Flue Fit Options
Standard
Conventional Class 1 | Conventional Class 2

Pre-Cast
Pre-Cast*

Heat Output
4.6kW

White

White & Grey slip

*For pre-cast model, please state when ordering.

Mariella

Micro Marble Gas Fireplace

48" Mariella gas fireplace in Manila micro marble complete with 900 gas fire

W1220mm
48" H1089mm
D400mm

Heat Output
5.1kW

Flue Fit Options

Standard

Brick Chimney
Class 1

Pre-fabricated
Class 2



BV



EEC: D

Manila

White

W1220mm
48" H1089mm
D400mm

Heat Output
5.1kW

Flue Fit Options

Pre-Cast

Pre-Cast

Orieta

Micro Marble Gas Fireplace

48" Orieta gas fireplace in White micro marble complete with 900 gas fire



BV



EEC: D

Manila

White

Earlston

Micro Marble Gas Fireplace

48" Earlston gas fireplace in White micro marble complete with 950 gas fire



SL



EEC: E

W1220mm
48" H897mm
D400mm

Flue Fit Options
Standard
Conventional Class 1 | Conventional Class 2

Pre-Cast
Pre-Cast*

Heat Output
4.6kW



White

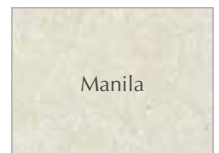

Manila

*For pre-cast model, please state when ordering.

Micro Marble Electric Fireplaces

With a style as beautifully different as the décor and furniture you seek to match, our micro marble electric fireplaces are as individual as you are. Offering 2kW of efficient heat and instant warmth, the flickering flame effect adopts the latest LED technology to produce a play of warming fire like tones that are both realistic and cost effective.

Contents

Cabrina.....	33
Vistus	34
Alesso.....	35
Cassius	36
Vitalia.....	37
Amorina	38
Wayland.....	38
Embleton	39
Wellsford.....	40
Farnham	41
Willaston	42
Cotsmore.....	43

22" Fire Switch Option

A selection of our electric fireplaces now come with multiple fire options. Look for the 22" Switch symbol within the inset electric fires section, from page 68. Bespoke your fireplace to your home.



Flame effect

The flame-effect-only setting gives the impression of radiant logs and flickering flames with a choice of three flame effects and brightness levels without the added heat; perfect for warmer nights. The latest LED technology produces a play of warming fire like tones that are both realistic and cost effective.

Flat to wall fix

This amazing transformation can be fitted in half a day at the most. Because it's electric no chimney or recess is required. It's just a case of simply plugging it in... and let the magic begin.

A white circular icon with the text "FLAT WALL FIX" centered inside in a bold, sans-serif font.

FLAT
WALL FIX

Cabrina

— Pryzm Micro Marble Electric Fireplace —

52" Cabrina electric fireplace in White micro marble complete with the new Pryzm 5D 750P fire



P R Y Z M
REVOLUTIONIZING FLAMES

52" W1320mm
H1040mm
D400mm

Heat Output
up to 2kW

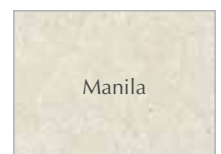

Vistus

— Pryzm Micro Marble Electric Fireplace —

48" Vistus electric fireplace in White micro marble complete with the Pryzm 5D 750 fire



PRYZM
REVOLUTIONIZING FLAMES

48" W1220mm
H830mm
D400mm

Heat Output
up to 2kW

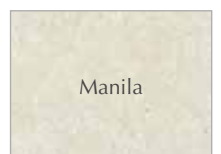

Alesso

— Pryzm Micro Marble Electric Fireplace —

48" Alesso electric fireplace in Manila micro marble featuring the new Pryzm 5D 750P fire



P R Y Z M
REVOLUTIONIZING FLAMES

48" W1220mm
H1000mm
D400mm

Heat Output
up to 2kW



White

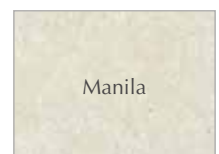

Manila

Cassius

Micro Marble Electric Fireplace

52" Cassius electric fireplace in White micro marble complete with 950 widescreen electric fire



W1320mm
52" H967mm
D400mm

Heat Output
up to 2kW



Vitalia

Micro Marble Electric Fireplace

48" Vitalia electric fireplace in Manila micro marble complete with 900 electric fire



48" W1220mm
H1080mm
D400mm

52" W1320mm
H1150mm
D400mm

Heat Output
up to 2kW

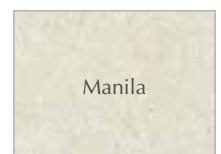

Amorina

Micro Marble Electric Fireplace

50" Amorina electric fireplace in White micro marble complete with Chollerston electric fire in Black Nickel

W1270mm
50" H1040mm
D300mm

Heat Output
Up to 2kW



Manila

White

SL



FLAT WALL FIX

W1320mm
52" H947mm
D400mm

Heat Output
up to 2kW

Wayland

Micro Marble Electric Fireplace

52" Wayland electric fireplace in Manila micro marble complete with 950 widescreen electric fire



Manila

White

SL



FLAT WALL FIX

Embleton

Micro Marble Electric Fireplace

52" Embleton electric fireplace in White & Grey slip micro marble complete with 900 electric fire



52" W1320mm
H1159mm
D400mm

Heat Output
up to 2kW

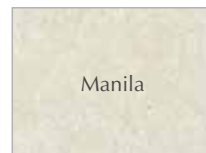

Wellsford

Micro Marble Electric Fireplace

52" Wellsford electric fireplace in White micro marble complete with widescreen electric fire and Anthracite trim



52" Wellsford electric fireplace in Manila micro marble complete with widescreen electric fire and Brushed Steel trim

52" W1320mm
H855mm
D300mm

Heat Output
up to 2kW

Brushed Steel or
Anthracite Trim



White

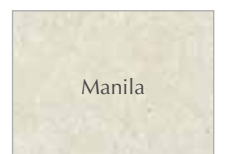

Manila

Farnham

Micro Marble Electric Fireplace

48" Farnham electric fireplace in White micro marble complete with a 22" Chollerton electric fire finished in Black Nickel



44" W1120mm
H930mm
D240/400mm

48" W1220mm
H965mm
D240/400mm

Heat Output
up to 2kW



White

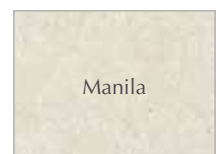

Manila

Willaston

Micro Marble Electric Fireplace

52" Willaston electric fireplace in White micro marble with Grey slip complete with 22" Pryzm electric fire with Chollerlerton fascia in Chrome



P R Y Z M
REVOLUTIONIZING FLAMES

52" W1320mm
H1159mm
D400mm

Heat Output
up to 2kW



Cotsmore

Micro Marble Electric Fireplace

46" Cotsmore electric fireplace in White micro marble complete with 22" Chollerton electric fire in Chrome



W1170mm
46" H960mm
D400mm

Heat Output
up to 2kW

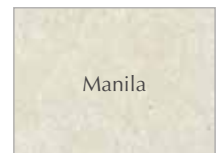

Timber Electric Fireplaces

Our timber electric fireplaces offer the ultimate convenience; they can be installed against any flat wall in any room. These innovative designs are a desirable centrepiece and the 2kW performance provides instant heat when you arrive home, which can supplement the central heating or allow you to heat just one room when the weather is on the cool side.

Contents

Amorina	45
Velino	46
Arana	47
Lavina.....	48
Wellsford.....	49
Edwin	50
Bracken	51

Flame effect

The flame-effect-only setting gives the impression of radiant logs and flickering flames with a choice of multiple flame effects & brightness levels without the added heat; perfect for warmer nights. The latest LED technology produces a play of warming fire like tones with that are both realistic and cost effective.



7 day Thermostatic Remote Control

An Elgin & Hall inset fire should be effortless to operate. Which is why they come complete with a remote control* to put different levels of heat, light and flame at your fingertips.

*Unless otherwise stated

Flat to wall fix

This amazing transformation can be fitted in half a day at the most. Because it's electric, no chimney or recess is required. It's just a case of simply plugging it in... and let the magic begin.

FLAT
WALL FIX

Amorina

Timber Electric Fireplace

50" Amorina electric fireplace in Pearlescent Cashmere painted finish with 22" Chollerston electric fire in Chrome



SL

7 DAY

FLAT WALL FIX

50" W1270mm
H1016mm
D300mm

Heat Output
up to 2kW

Pearlescent
Cashmere

Almond Stone

Velino

Pryzm Timber Electric Fireplace

52" Velino electric fireplace in Ash White painted finish with the Pryzm 5D 750P electric fire



52" W1320mm
H1091mm
D350mm

Heat Output
up to 2kW

Ash White

Arana

— Pryzm Timber Electric Fireplace —

50" Arana electric fireplace in Ash White painted finish with the new Pryzm 5D 750P electric fire



SL

7 DAY

FLAT WALL FIX

PRYZM
REVOLUTIONIZING FLAMES

50" W1270mm
H1021mm
D350mm

Heat Output
up to 2kW

Ash White

Lavina

— Pryzm Timber Electric Fireplace —

50" Lavina electric fireplace in Ash White painted finish with the new Pryzm 5D 750 electric fire



W1270mm
50" H851mm
D350mm

Heat Output
up to 2kW

Ash White

Wellsford

— Timber Electric Fireplace —

52" Wellsford electric fireplace in Soft White painted finish with Anthracite back panel complete with widescreen electric fire and Brushed Steel trim



52" Wellsford electric fireplace in Pearlescent Cashmere painted finish with Anthracite back panel complete with widescreen electric fire and Anthracite trim



BV

7 DAY

FLAT WALL FIX

52" W1320mm
H875mm
D300mm

Heat Output
up to 2kW

Brushed Steel or
Anthracite Trim

Pearlescent
Cashmere

Soft White

Edwin

— Timber Electric Fireplace —

52" Edwin electric fireplace in a Matt Cashmere paint finish. Complete with a Black Nickel inlay and a 950 widescreen electric fire



52" W1320mm
H936mm
D280mm

Heat Output
up to 2kW

Matt Cashmere

Bracken

— Timber Electric Fireplace —

46" Bracken electric fireplace in Soft White painted finish featuring a Country Oak top complete with electric stove



BN
FLAT WALL FIX

46" W1170mm
H990mm
D380mm

Heat Output
up to 2kW

Ivory, Anthracite
& Country Oak*

Soft White &
Country Oak

*Only available with Anthracite back panel & hearth

Inset Gas Fires

Once you've selected your new surround, you may choose to give it a warm glowing heart with an Elgin & Hall gas fire.

Our gas fires are controllable and convenient to operate with a discreet Smartslide control mounted on the top side or a manual control and igniter located behind the fret - flame height and heat output is at your control.

Contents

Flue & Engine Introduction	53-55
16" Inset Gas Fires	56-57
Cast Collection	58
16" Chollerton Gas	59
22" Chollerton Gas	60
22" Chollerton Cast Stove Front	61
Calleos 800CF	62-63
Elsie 960BF	64-65

Warranty

We provide a 5 year Warranty* so you can be confident you have purchased and installed a high quality product.

*Terms & conditions apply.

Installation

Current regulations stipulate that all gas fire installations must be carried out by a Registered Gas Safe Engineer.

For information and advice on a Gas Safe Engineer, please contact your local Elgin & Hall retailer.

Servicing

We recommend that all gas fires are serviced annually by a Registered Gas Safe Engineer to ensure continued operation and optimum performance.

This annual service is a condition of our 5 year warranty, and you must be able to show a record of approved servicing to be able to make a claim.

Safety Assurance



Flame Failure Device

All of our gas fires are fitted with a flame monitoring device ensuring that in the event of the flame going out during its operation, the gas supply to the fire is instantly cut off.



Oxygen Depletion Sensor

For your safety, all our gas fires are fitted with an Oxygen Depletion Sensor. This will shut off the gas supply if the oxygen level in the room is too low or if there is a blockage in the chimney or flue.



Quality Approved

All Elgin & Hall fires are manufactured in accordance with internationally recognised Quality and Environmental Management System Standards ISO 9001:2015 and ISO 14001:2015 guaranteeing responsible working and product quality.

Accessories



Xtra Canopy

The Xtra canopy kit* "tunes" the appliance to your flue to raise the efficiency by up to 8% on an open fronted fire.

*Available on Slimline or Deepline Radiant models only



Spacer Kit

The spacer kit fits to the rear of the fire to reduce the depth by 25mm. It is ideal for use with pre-cast flues.



Handle Options

An easy grip* attachment allows those with restricted movement to control the ignition & heat.

Matching colour handles are available in Brass & Chrome. A Black Smartslide handle is supplied as standard with Smartslide models.

*Easy grip handle not suitable for Chollerton gas fire.

Super Controllable



Smartslide Control

The discreet Smartslide control mounted at the top right hand side makes your Elgin & Hall gas fire convenient to operate. To turn the fire on simply press down and release.

Likewise you can turn the fire off by lifting to its top position. The control's second function is to regulate the flame height and heat output.

Smartslide controls give you the freedom to change the fire picture from smouldering to blazing at a touch to suit your mood and desired room temperature.



Manual Control

All our open fronted gas fires are available as manual control. Neatly concealed behind the fret, these controls allow you to regulate your heat output and flame setting before replacing the fret for a sleek finish.

The various types of flue and chimney require different size specifications of gas fire.

Whichever kind your home has, there is an Elgin & Hall gas fire to fit.

Gaze over the next few pages and you will easily identify which one is suitable for your home.



Consider the fit

All of our gas fires require a chimney or flue to conduct expended gases to the exterior. To identify which type your house has and which model of fire will fit (slimline, mid-depth or deepline), check the simple descriptions below.

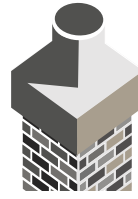

Brick Chimney Flues Class 1

Easily recognisable from the stack above the roof line (usually with a pot or gas terminal).

Once the fire is sealed into the chimney cavity, any harmful gases are expelled up the chimney itself and out of the roof. Any of our gas fires can be installed here.

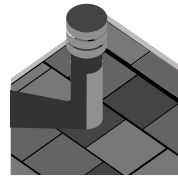

Pre-Fabricated Flues Class 2

Identifiable by a metal flue and terminal on the roof, this flue system is suitable for all our gas fires. Piping from your flue right down to your fire transports the gasses from the fire and out of the house. Again this flue is suitable for installation with any of our gas fires.

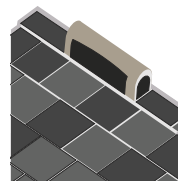

Pre-Cast Flues

Recognisable by a ridge vent on the roof line, and built from concrete or clay blocks, usually within the wall cavity, the expelled gasses are vented through this shallow passage and out of the roof. Pre-cast flues are perfect for our Slimline or Deepline * Radiant gas fires.

* Deepline Radiant fire suitable when installed with a 75mm rebated surround.

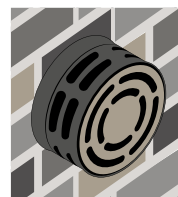

Balanced Flue

Identified by a round flue installed directly through an external wall. Our balanced flue fire is completely sealed from the front, allowing air to circulate through the flue to the rear of the fire. Cold air is sucked into the fire to combust and the gasses are expelled via the same point. This fire is highly efficient due to its airtight installation and can be installed without a chimney breast.

Choosing the right engine

Open Fronted

Slimline Radiant

Radiant gas fires pull in cold air through their open front, circulating it over the real flames and emitting it back into the room.

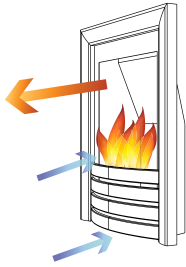

Deepline Radiant

Deepline Convector

Hot air is transferred through the canopy to circulate the warmth around the room.

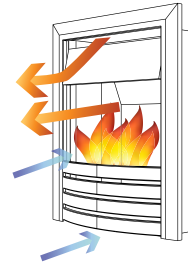
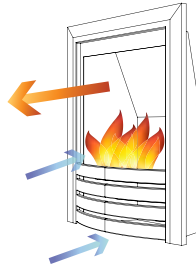

Flue Type	Conventional Class 1 & 2 + Pre-Cast			
Gas Type	Natural Gas			
Efficiency	52% (58% with Xtra canopy)			
Control	Smartslide or Manual			
EEC	F			
EEL (%)	43% (48% Canopy)			
	High	Canopy	Low	Canopy
Heat Input: Manual Smartslide	6.75kW		3.5kW	
Heat Output: Manual Smartslide	3.2kW	3.5kW	1.5kW	1.7kW
			1.3kW	1.4kW

Flue Type	Conventional Class 1 & 2 + Pre-Cast*			
Gas Type	Natural Gas			
Efficiency	52% (55% with Xtra canopy)			
Control	Smartslide or Manual			
EEC	F			
EEL (%)	43% (46% Canopy)			
	High	Canopy	Low	Canopy
Heat Input: Manual Smartslide	6.75kW		3.5kW	
Heat Output: Manual Smartslide	3.2kW	3.4kW	1.5kW	1.6kW
			1.3kW	1.4kW

Flue Type	Conventional Class 1 & 2	
Gas Type	Natural Gas	
Efficiency	62%	
Control	Smartslide or Manual	
EEC	F	
EEL (%)	55%	
	High	Low
Heat Input: Manual Smartslide	6.75kW	3.5kW
Heat Output: Manual Smartslide	3.8kW	1.8kW
		1.6kW

Glass Fronted

Mid-Depth

Deepline

Chollerton

A panel of ceramic glass prevents air from being sucked up through the front of the fire and directing heat up the chimney, meaning a higher percentage of convected and radiant heat is propelled back into the room.

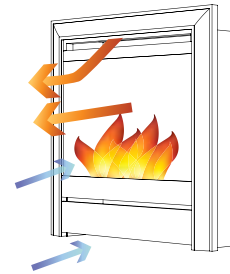
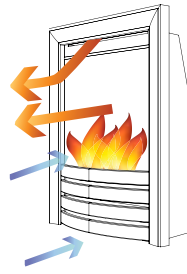
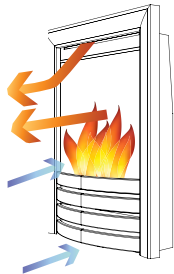

Flue Type	Conventional Class 1 & 2 + Pre-Cast	
Gas Type	Natural Gas	
Efficiency	82%	
Control	Smartslide	
EEC	D	
EEL (%)	73%	
Heat Input	High 3.7kW	Low 2.5kW
Heat Output	High 2.7kW	Low 1.7kW

Flue Type	Conventional Class 1 & 2	
Gas Type	Natural Gas	
Efficiency	87%	
Control	Smartslide	
EEC	C	
EEL (%)	78%	
Heat Input	High 5.3kW	Low 2.7kW
Heat Output	High 4.2kW	Low 2kW

Flue Type	Conventional Class 1 & 2	
Gas Type	Natural Gas	
Efficiency	16" = 83% 22" = 86%	
Control	Smartslide	
EEC	16" = C 22" = C	
EEL (%)	16" = 77% 22" = 77%	
	High	Low
Heat Input: 16"	4.8kW	3kW
Heat Input: 22"	5.3kW	2.7kW
Heat Output: 16"	3.6kW	2.1kW
Heat Output: 22"	4.3kW	1.8kW

Balanced Flue Glass Fronted

This glass fronted balanced flue gas fire is pleasingly traditional with a welcome efficiency of 86% and a cosy 3.3kW heat output.

Complete with Balanced Flue Kit.

* When installed with a 75mm rebate surround Energy Efficiency Class (EEC)

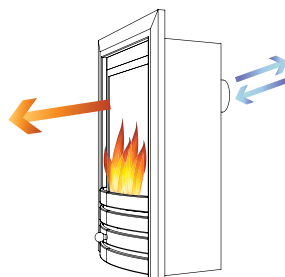

Flue Type	Balanced Flue	
Gas Type	Natural Gas	
Efficiency	86% EEC:C	
Control	Smartslide or Manual	
EEL (%)	77%	
	High	Low
Heat Input: Manual Smartslide	4.2kW	2.9kW
Heat Output: Manual Smartslide	3.3kW	2.1kW
		2kW

16" Inset Gas fires



Our range of gas fires are available with an extensive choice of trims and frets to suit your style. Simply select your preferred collection, then choose your finish.

Fire Engine	(C) Inset Depth	Flue Type	Gas Type	Minimum Aperture in Chimney	Open or Glass Fronted	Xtra Canopy
Slimline Radiant	123mm	Conventional Class 1 & 2 + Pre-Cast	Natural Gas	W405mm x H555mm	Open Fronted	<input checked="" type="checkbox"/>
Deepline Radiant	173mm	Conventional Class 1 & 2 + Pre-Cast	Natural Gas			<input checked="" type="checkbox"/>
Deepline Convector	198mm	Conventional Class 1 & 2	Natural Gas			<input checked="" type="checkbox"/>
Mid Depth H.E	128mm	Conventional Class 1 & 2 + Pre-Cast	Natural Gas		Glass Fronted	<input checked="" type="checkbox"/>
Deepline H.E	198mm	Conventional Class 1 & 2	Natural Gas			<input checked="" type="checkbox"/>
Balanced Flue*	186mm	Balanced Flue	Natural Gas	N/A		<input checked="" type="checkbox"/>

*Includes: Balanced Flue kit

Exclusive Fascia Collection

The framework of the Exclusive trim has a flat face with a long bevelled edge that slopes down towards the fire. The trim is broad and slightly accented in profile to complement the four boldly curving bands of the fret.

In Brushed Steel, Brass, Chrome or Black, the harmony of the trim and fret creates a non-fussy but sympathetic note to a stylish interior.

Available finishes:



Devotion Fascia Collection

The distinguishing feature of this range of designs is the Black finished framework bordering either side of the metal trim. This serves to provide a dramatic contrast which accentuates the Chrome, Brass, Nickel or Brushed Steel finish. The fret itself curves slightly outwards to add extra interest.

Available finishes:



Dimensions

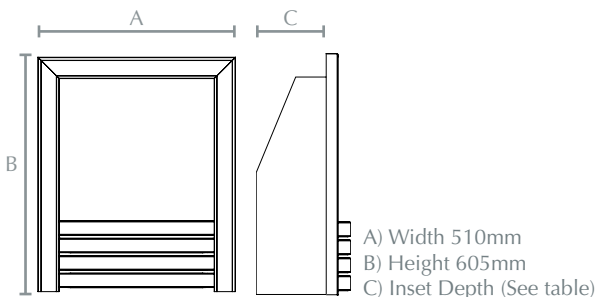

Exclusive trim profile

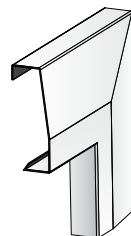

Devotion trim profile

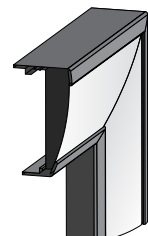

———— Classic Collection ————

The harmony of the trim and cast fret on the Classic gas fire collection offers clean lines yet remains in keeping to a cutting edge interior. A classic in the making – of that you can be confident. Simply select your preferred fire, whether that is Slimline or Deepline, Manual or Smartslide control and add a trim in Black, Brass, Brushed Steel, Black Nickel or Chrome finish. Then choose your Classic fret to complement your style – the Hampden, Belmont and Brantley fret each offers a unique flair and finish.

———— Choose your Gas Fire Engine complete with Trim ————

Exclusive finishes:

Devotion finishes:



———— Choose your Fret ————

Hampden



Chrome



Chrome / Black



Brass / Black



Black Nickel

Belmont



Chrome



Black / Chrome



Brass



Black Nickel

Brantley



Chrome



Brass



Black Nickel



Exclusive Brass trim with Hampden Brass / Black fret



Exclusive Black trim with Belmont Black / Chrome fret



Devotion Chrome trim with Brantley Chrome fret

Cast Collection

Experience the look and feel of a real stove with the Cast Stove Front in Matt Black finish. Fixes directly onto our glass fronted gas fires so you can experience the high efficiency and controllable flames with a real stove appearance. Also available as a Cast Stove Front Widescreen Gas fire. (see page 61)

Give your fireplace and room a different aesthetic with the Cast Stove Front gas fire. A heavy cast iron trim finishes these fires to give the desirable appearance of a stove.

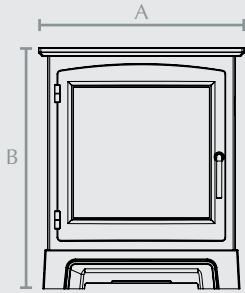

A) Width 562mm
B) Height 659mm

Suitable for

- Mid Depth H.E
- Deepline H.E
- Balanced Flue

————— 16" Cast Stove Front —————



The Eclipsim Cast Fascia in Matt Black finish with polished detail. Fixes directly onto all our gas fires (excluding Deepline Convector) so you can enjoy the high efficiency and controllable flames with a stylish appearance.

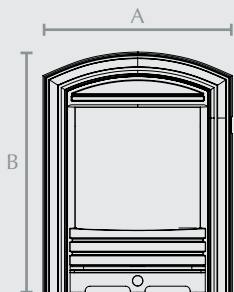

A) Width 563mm
B) Height 716mm

Suitable for

- Slimline Radiant*
- Deepline Radiant*
- Mid Depth H.E
- Deepline H.E
- Balanced Flue

————— Eclipsim Cast Fascia —————



16" Chollerton Gas

With realistic logs, the unique dual burner system allows the fire to be turned to low whilst still retaining an impressive flame height. Reflective black glass back panels offer the best flame picture and an impressive 3.7kW heat output. A choice of trim options and finishes complete this product to perfection.



Chollerton Trim - Chrome



Edge Trim - Black Nickel

— NEW —



Cast Stove Front

Fascia Finish	Chrome, Black Nickel or Cast Stove front
Back Panel Cut Out	W405 x H595mm
Min / Max Output	2.2 / 3.7kW
Control	Smartslide
Efficiency	86% / EEC:C / EEI:77%
Flue Type	Conventional Class 1 & 2
Gas Type	Natural Gas
Fascia Options	Chollerton, Edge or Cast Stove Front

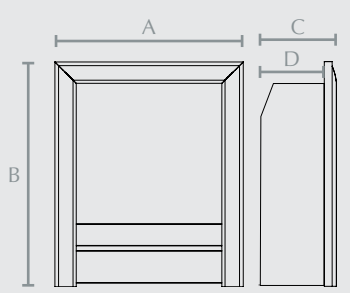

A) Width 512mm 511mm (Edge)
 B) Height 611mm
 C) Depth 232mm
 D) Inset Depth 197mm

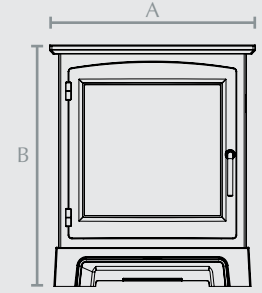

A) Width 562mm
 B) Height 659mm

22" Chollerton Gas Fire

The Chollerton is a stylish glass fronted, high efficiency fire, offering an impressive 86% efficiency. Available in Black Nickel, Brushed Steel or Chrome there is a finish to suit your chosen surround. The Chollerton Gas, a 22" widescreen style for a 16" wide builders opening, requires a 75mm rebated surround.



Black Nickel



Chrome

Fascia Finish	Chrome or Black Nickel
Back Panel Cut Out	W570 x H595mm
Min / Max Output	1.8 / 4.3kW
Control	Smartslide
Efficiency	86% / EEC:C / EEI:77%
Flue Type	Conventional Class 1 & 2
Gas Type	Natural Gas

Dimensions

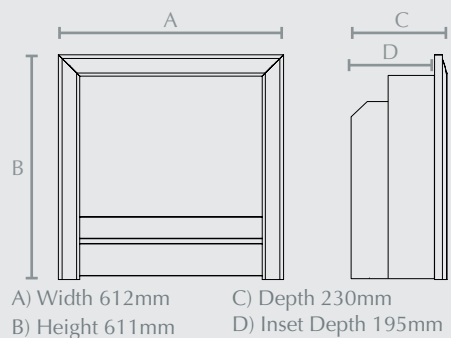

Easy installation

W: 405mm-460mm
H: 565mm-590mm
D: 260mm (min)

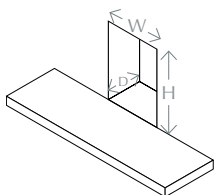

Step 1

Secure the **Fire Box & Fixing Plate** assembly into the fireplace opening

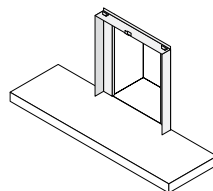

Step 2

Position the **Back Panel** onto the fixing plate.

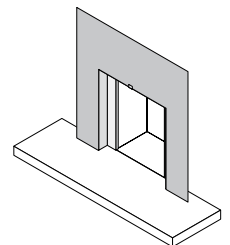

22" Chollerton Cast Stove Front

Experience the look and feel of a real stove with the Cast Stove Front in Matt Black finish. Fixing directly onto our Chollerton Widescreen gas fire, you can enjoy the high efficiency and controllable flames with a traditional stove appearance. Requires a 75mm rebated surround.



Fascia Finish	Matt Black
Back Panel Cut Out	W570 x H595mm
Min / Max Output	1.8 / 4.3kW
Control	Smartslide
Efficiency	86% / EEC:C / EEI: 77%
Flue Type	Conventional Class 1 & 2
Gas Type	Natural Gas

Dimensions

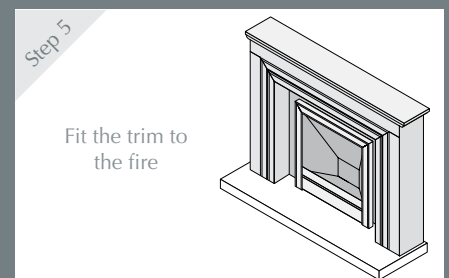
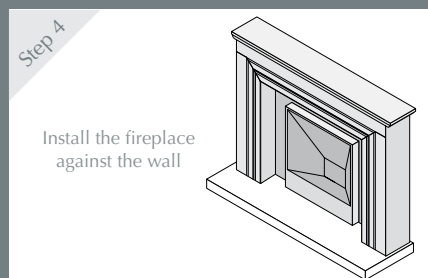
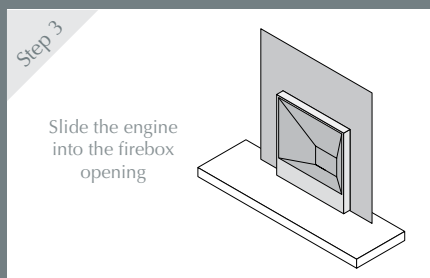
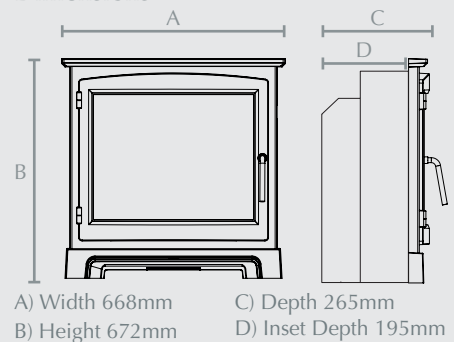

Calleos 800CF

Inset wall mounted gas fire

The Calleos 800CF is one of the most exciting developments in glass fronted gas fires and is suitable for both conventional class 1 and class 2 flues.

Shown here installed with a Slim or **optional extra Wide* trim**, this gas fire fits directly into a fireplace wall for a minimalistic look. The Calleos 800CF features the latest in under-log dual burner technology and is sure to impress with its stunning fuel bed layout and reflective black glass internal panels.

The unique dual burner system allows the fire to be turned to low whilst still retaining an impressive flame picture.

With up to 4.4kW of instant heat, the Calleos 800CF is sure to impress. Indulge in the ultimate luxury and opt for the **optional non-reflective* glass** which will amaze your viewing pleasure, creating the illusion of no glass, simply, crystal clear.

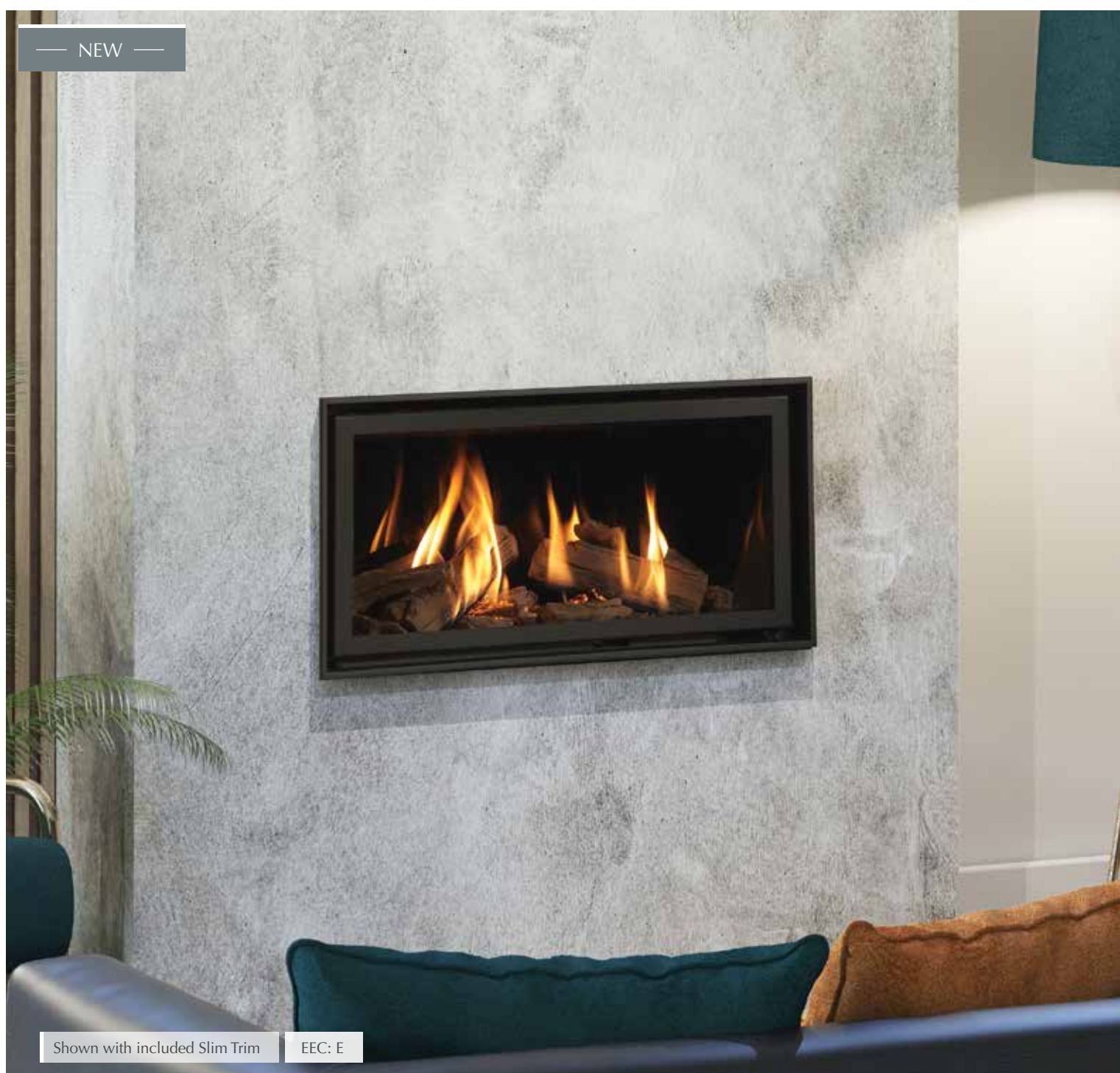

— NEW —

Shown with included Slim Trim

EEC: E

Fascia Finish	Matt Black Slim Trim or optional extra Wide* Trim
Min / Max Output	2.9 / 4.4kW
Control	Smartslide
Efficiency	74.7% / EEC:E
Flue Type	Conventional Class 1 & 2
Gas Type	Natural Gas
Fascia Options	Matt Black Slim or Wide* trim
Glass Options	Standard or Non Reflective* glass

* Optional Extra

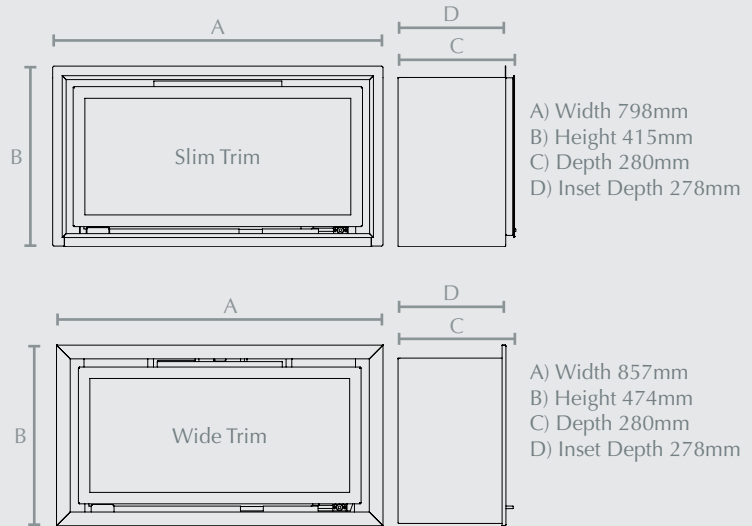

Elsie 960BF

Balanced Flue inset wall mounted gas fire

The Elsie 960BF balanced flue gas fire is suitable for homes without a chimney. The highly efficient slimline hole in the wall fire can be installed onto any outside wall of the home and generates a contemporary and stylish centrepiece for the room.

This appliance can be installed directly into a cavity wall yet still provides a very deep fuel bed effect for a product of its type. Coupled with a reflective black glass lining, the gas fire delivers a captivating flame effect and beautiful ceramic log layout.

- Inbuilt convector box for cooler wall temperatures
- Balanced flue for cavity wall
- Reflective black glass
- Discreet slide control operation
- Easy to install – easy to service
- Deep fuel bed
- Flush fitting



EEC: C

Fascia Finish	Brushed Steel trim
Min / Max Output	2.1 / 4.6kW
Control	Smartslide
Efficiency	86% / EEC:C / EEl: 77%
Flue Type	Balanced Flue
Gas Type	Natural Gas

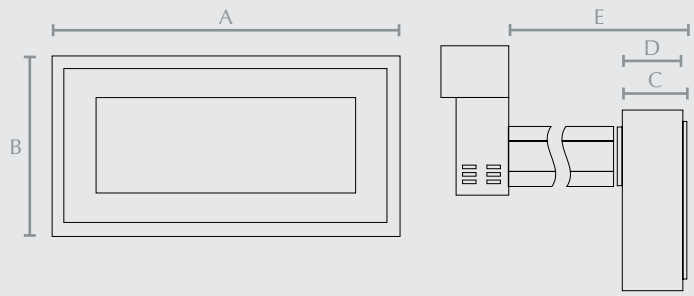

- A) Width 1198mm
- B) Height 666mm
- C) Depth 187mm
- D) Inset Depth 174mm
- E) Wall Depth min 270 - max 725mm



Inset Electric Fires

Whichever Elgin & Hall micro marble surround you choose, the centre attraction is the fire itself, inset into the back panel.

Whether you are replacing a gas or coal fire or installing a natural focus to a room with no existing fireplace, going electric allows you to connect with clean, instant, efficient and thermostatically controlled heat.

Contents

22" Pryzm Electric - Cast Stove Front	67
22" Pryzm Electric	68-69
16" Pryzm Electric	70-71
22"-16" Chollerton	72-73
16" Chollerton	74
16" Chollerton Edge	74
Inset Stoves	75
Beacon Stove	76
Inset Beacon Stove	77

22" Fire Switch Option

A selection of our 22" electric fires can be chosen to complement a collection of our electric fireplaces. Look out for the 22" Switch symbol within the Micro Marble electric fireplaces section from page 34.



Benefits

With an electric fire you don't need to generate heat to enjoy its comforting glow. The LED flame effect only control option, lets you experience it any time of the day or year.

Efficient

Enjoy the convenience of efficient, instantly controllable heat and clean maintenance free living. By itself the LED only effect consumes just 6 watts of energy.



Manual Switches

Are easily accessible with main functions.



7 day Thermostatic Remote Control

An Elgin & Hall inset fire should be effortless to operate. Which is why they come complete with a remote control* to put different levels of heat, light and flame at your fingertips.

*Unless otherwise stated

22" Pryzm Inset Electric Fire - Cast Stove Front

The stunning Cast Stove Front offers a luxury touch to the 22" Pryzm inset electric fire. Finished in Matt Black the Cast Stove Front provides the look and feel of a real stove with the ease of electric. A 7 day programmable thermostatic remote control adds the convenience of controlled heat.



Cast Stove Front fascia in Matt Black

Fascia Finish	Cast Stove front*: Matt Black
Inset Depth Required	140mm
Back Panel Cut Out	W570 x H595mm
Heat Output	Up to 2kW
Control	7 Day Thermostatic Remote Control

* Spacer frame not compatible with Cast Stove Front

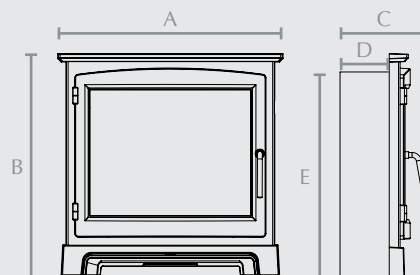

- A) Width 668mm
- B) Height 672mm
- C) Depth 205mm
- D) Inset 140mm
- E) Rear Height 565mm

22" Pryzm Inset Electric Fire

There's no denying the visual impact of the 22" Pryzm inset electric fire. The panoramic glass screen ensures optimum flame performance and the glowing ember effect with miniature pebble fuel bed can be truly appreciated. A 7 day programmable thermostatic remote control adds the convenience of controlled heat.



Chollerton fascia in Chrome



Chollerton fascia in Black Nickel

Chollerton Trim	
Fascia Finish	Chollerton: Chrome or Black Nickel
Inset Depth Required	140mm / 75mm (with spacer frame)
Back Panel Cut Out	W570 x H595mm
Heat Output	Up to 2kW
Control	7 Day Thermostatic Remote Control

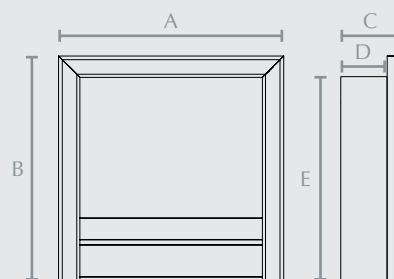

- A) Width 612mm
- B) Height 611mm
- C) Depth 170mm
- D) Inset 140mm
- E) Rear Height 565mm



Edge fascia in Black Nickel



Edge fascia in Chrome

Edge Trim	
Fascia Finish	Edge: Chrome or Black Nickel
Inset Depth Required	140mm / 75mm (with spacer frame)
Back Panel Cut Out	W570 x H595mm
Heat Output	Up to 2kW
Control	7 Day Thermostatic Remote Control

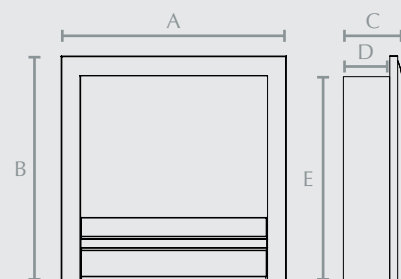

A) Width 611mm
 B) Height 611mm
 C) Depth 170mm
 D) Inset 140mm
 E) Rear Height 565mm

16" Pryzm Inset Electric Fire

Let the 16" Pryzm inset electric fires transform your home to a new level of contemporary living. The glorious patent pending 5D flame effect and loose logs create a new level of realism. Enjoy the 2kW heat output at your convenience with the 7 day programmable thermostatic remote control. Select your perfect style from a wide choice of fascia's shown below.



Chollerton fascia in Black Nickel



Edge fascia in Black Nickel



Devotion fascia in Chrome

Fascia Finish	Chollerton: Chrome or Black Nickel
	Edge: Chrome or Black Nickel
	Devotion: Chrome, Brushed Steel, Brass or Black Nickel
	Classic Devotion + Belmont fret: Chrome, Black, Brass or Black Nickel
	Classic Devotion + Hampden fret: Chrome, Black, Brass or Black Nickel
	Classic Devotion + Brantley fret: Chrome, Brass or Black Nickel
Inset Depth Required	140mm / 75mm (with spacer frame)
Back Panel Cut Out	W413 x H565mm
Heat Output	Up to 2kW
Control	7 Day Thermostatic Remote Control

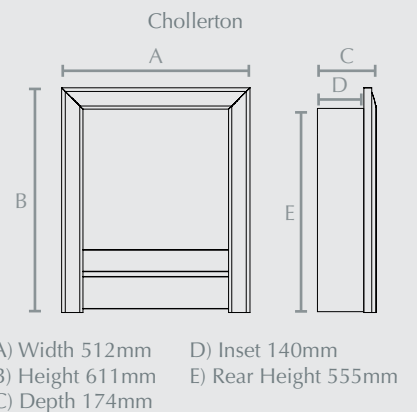



Classic Devotion trim + Belmont Fret in Brass



Classic Devotion trim + Brantley fret in Chrome



Classic Devotion trim + Hampden fret in Black Nickel

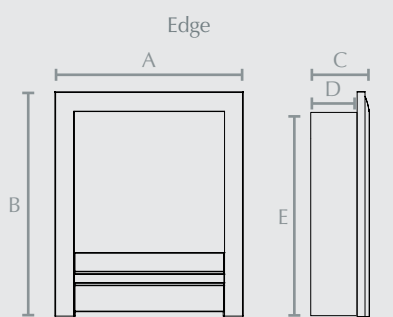

A) Width 511mm
 B) Height 611mm
 C) Depth 174mm
 D) Inset 140mm
 E) Rear Height 555mm

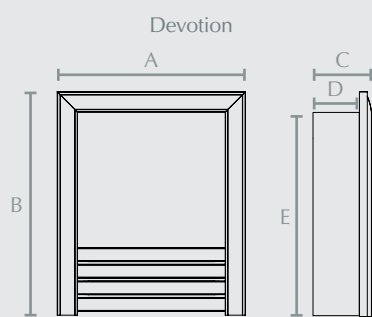

A) Width 510mm
 B) Height 605mm
 C) Depth 174mm
 D) Inset 140mm
 E) Rear Height 555mm

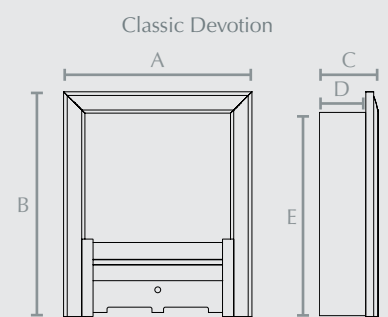

A) Width 510mm
 B) Height 605mm
 C) Depth 174mm
 D) Inset 140mm
 E) Rear Height 555mm

22" - 16" Chollerton Inset Electric Fire

Our 22" to 16" Chollerton inset electric fire is the perfect solution to fit a 22" cut out back panel which sits against a standard 16" chimney opening. There's no need to make any alterations to your chimney, meaning you can relax and enjoy the warming aesthetic, without costly building work.



Chollerton Black Nickel



Chollerton Chrome



Edge Chrome



Edge Black Nickel

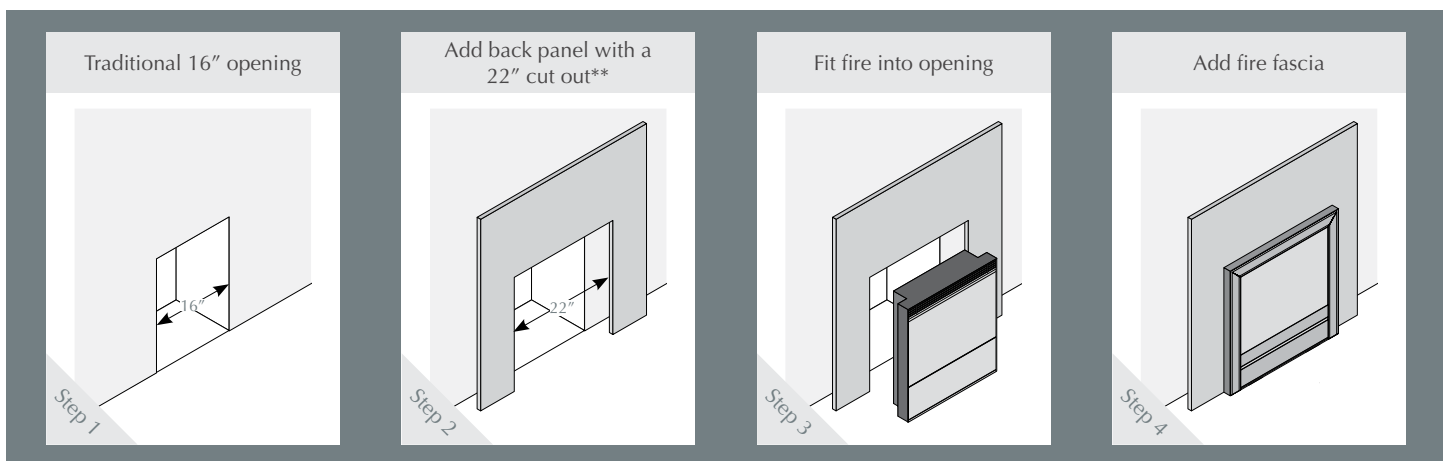

**The 22" - 16" Chollerton also fits a 16" back panel cut out against a standard 16" wide chimney opening with the use of a spacer frame.



Cast Stove front*

* Spacer frame not compatible with Cast Stove Front

Fascia Finish	Chollerton: Chrome or Black Nickel Cast Stove Front: Matt Black*** Edge: Chrome or Black Nickel
Inset Depth Required	140mm / 75mm (with spacer frame)
Back Panel Cut Out	W413 / 570 x H595mm
Heat Output	Up to 2kW
Control	7 Day Thermostatic Remote Control

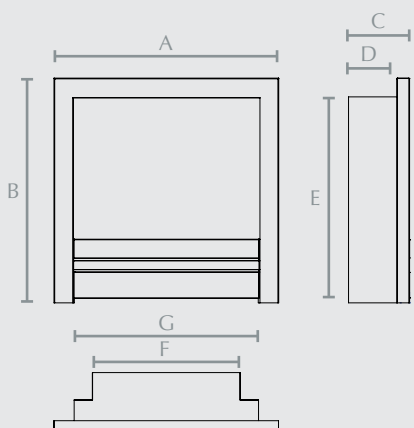

Chollerton / Edge
 A) Width 612/611mm
 B) Height 611/611mm
 C) Depth 170mm
 D) Inset 140mm
 E) Rear Height 565mm
 F) Inset Width 403mm
 G) Inset Width 503mm

Cast Stove Front
 A) Width 668mm
 B) Height 672mm
 C) Depth 170mm
 D) Inset 140mm
 E) Rear Height 565mm
 F) Inset Width 403mm
 G) Inset Width 503mm

***Only suitable with 22" back panel

16" Chollerton & Edge Inset Electric Fire

The 16" Chollerton inset electric fire is a beautiful addition to any home with its handcrafted log bed and choice of trims, including the Edge. Available with an optional spacer frame to allow simple installation into a 75mm rebate surround.



Fascia Finish	Chollerton: Chrome or Black Nickel Edge: Chrome or Black Nickel
Inset Depth Required	140mm / 75mm (with spacer frame)
Back Panel Cut Out	W413 x H595mm
Heat Output	Up to 2kW
Control	7 Day Thermostatic Remote Control

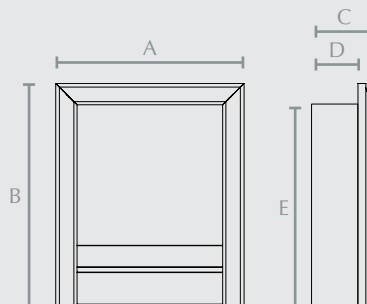

16" Chollerton

- A) Width 512mm
- B) Height 611mm
- C) Depth 174mm
- D) Inset 140mm
- E) Rear Height 555mm

16" Chollerton Edge

- A) Width 511mm
- B) Height 611mm
- C) Depth 165mm
- D) Inset 140mm
- E) Rear Height 555mm

Inset Stoves

Ora

Cast door with steel body
7 Day Programmable Thermostatic
Remote Control.
Heat Output: Up to 2kW

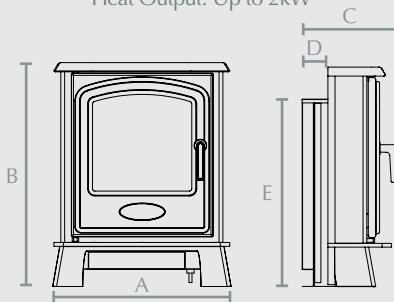

- A) Width 506mm
- B) Height 597mm
- C) Depth 249mm
- D) Inset 69mm
- E) Rear Height 534mm



Matt Black

Ignite

Cast door with steel body
7 Day Programmable Thermostatic
Remote Control.
Heat Output: Up to 2kW

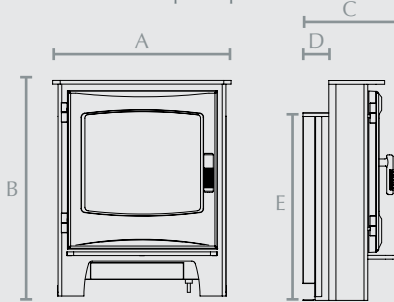

- A) Width 486mm
- B) Height 587mm
- C) Depth 236mm
- D) Inset 69mm
- E) Rear Height 500mm



Matt Black

Desire

Steel door & body
7 Day Programmable Thermostatic
Remote Control.
Heat Output: Up to 2kW

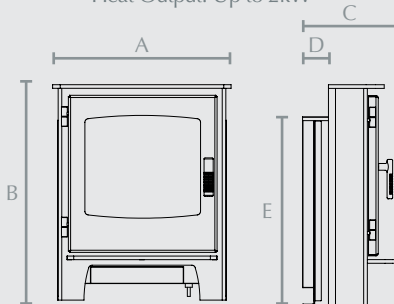

- A) Width 486mm
- B) Height 587mm
- C) Depth 238mm
- D) Inset 69mm
- E) Rear Height 500mm



Matt Black

Beacon Stove

A freestanding lightweight stove made from timber, but with the distinct appearance of steel, the Beacon offers an ultra-realistic flame effect and glowing log bed. Conveniently control the 2kW heat output with the 7 day programmable thermostatic remote control.



Large in Matt Black



Small in Ash White

Stove Finish	Matt Black or Ash White
Stove Heat Output	Up to 2kW
Stove Control	7 Day Thermostatic Remote Control
Stove Size	Small or Large
Rebate	N/A
Backpanel Cut Out Required	N/A

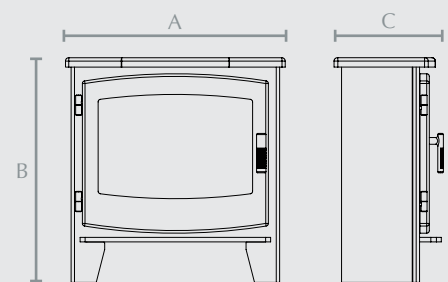

Small	Large
A) Width 486mm	A) Width 586mm
B) Height 599mm	B) Height 599mm
C) Depth 292mm	C) Depth 292mm

Beacon Inset Stove

The compact Beacon inset electric stove has a stylish timber body finished in our perfect Matt Black paint to give it the look of a steel stove. The panoramic window allows a stunning view of the brand new, ultra-realistic flame effect and glowing log bed making it a beautiful addition to any room. With a 45mm rebate making it perfect for any 45mm or 75mm rebated marble or timber surround



Stove Finish	Matt Black
Stove Heat Output	Up to 2kW
Stove Control	7 Day Thermostatic Remote Control
Stove Size	Small or Large
Rebate	45mm
Backpanel Cut Out Required	Will fit a standard 16" back panel cut out

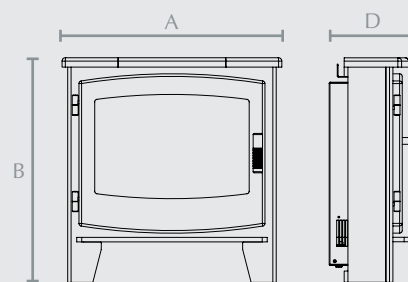

- | | |
|-----------------|-----------------|
| Small | Large |
| A) Width 486mm | A) Width 586mm |
| B) Height 599mm | B) Height 599mm |
| D) Depth 232mm | D) Depth 232mm |

Finishes & Dimensions



Micro Marble Surrounds

Page	Model	Mantel Width	Height	Hearth Width	Hearth Depth	Rebate	Smartsense Lights	Hearth Option	Finishes
10	Amorina*	1270mm (50")	1137mm	1270mm	400mm	45mm / 75mm	Optional	SL, FS, BN	A, B
8	Elento	1220mm (48")	1115mm	1220mm	400mm	45mm / 75mm	Optional	SL	C
8	Elento	1320mm (52")	1115mm	1320mm	400mm	45mm / 75mm	Optional	SL	C
16	Eliana	1220mm (48")	1155mm	1220mm	400mm	45mm / 75mm	Optional	SL, FS, BN	A, B
16	Eliana*	1320mm (52")	1155mm	1320mm	400mm	45mm / 75mm	Optional	SL, FS, BN	A, B
18	Florano	1070mm (42")	1050mm	1070mm	400mm	45mm / 75mm	Optional	SL	B, C
18	Florano	1220mm (48")	1095mm	1220mm	400mm	45mm / 75mm	Optional	SL, FS, BN	B, C
9	Mosello	1220mm (48")	1115mm	1220mm	400mm	45mm / 75mm	Optional	SL	C
9	Mosello	1320mm (52")	1115mm	1320mm	400mm	45mm / 75mm	Optional	SL	C
13	Odella - Inglenook ^{1*}	1370mm (54")	1235mm	1370mm	400mm*	75mm	Optional	SL	B
12	Odella*	1370mm (54")	1235mm	1370mm	400mm	75mm	Optional	SL	B
12	Odella*	1370mm (54")	1160mm	1370mm	400mm	75mm	Optional	SL	B
7	Roesia	1120mm (44")	1085mm	1120mm	400mm	45mm / 75mm	Optional	SL, FS, BN	B
7	Roesia*	1270mm (50")	1145mm	1270mm	400mm	45mm / 75mm	Optional	SL, FS, BN	B
17	Sophia	1170mm (46")	1085mm	1170mm	400mm	45mm / 75mm	Optional	SL, FS, BN	A, B
17	Sophia*	1270mm (50")	1145mm	1270mm	400mm	45mm / 75mm	Optional	SL, FS, BN	A, B
19	Timara	1070mm (42")	1050mm	1070mm	400mm	45mm / 75mm	Optional	SL	B, C
19	Timara	1220mm (48")	1095mm	1220mm	400mm	45mm / 75mm	Optional	SL, FS, BN	B, C
14	Verdena	1220mm (48")	1110mm	1220mm	400mm	45mm / 75mm	Optional	SL	A, B
14	Verdena*	1370mm (54")	1110mm	1370mm	400mm	45mm / 75mm	Optional	SL	A, B
15	Viena	1220mm (48")	1110mm	1220mm	400mm	45mm / 75mm	Optional	SL	A, B
15	Viena*	1370mm (54")	1110mm	1370mm	400mm	45mm / 75mm	Optional	SL	A, B
11	Vitalia	1220mm (48")	1080mm	1220mm	400mm	45mm / 75mm	Optional	SL, FS, BN	A, B
11	Vitalia*	1320mm (52")	1040mm	1320mm	400mm	45mm / 75mm	Optional	SL, FS, BN	A, B

*Back panel available with 22" cut out for installation with the Chollerton gas or electric fires. NB: all of our surrounds are available with Smartsense lights
¹Not suitable for solid fuel stoves | • Inglenook rear hearth supplied - 1016x457x20mm | Inglenook Back Panels not supplied

Limestone Surrounds

Page	Model	Mantel Width	Height	Hearth Width	Hearth Depth	Rebate	Smartsense Lights	Back Panel	Hearth	Finish
23	Aurelia	1220mm (48")	1105mm	1220mm	400mm	75mm	As standard	16"	SL	D
21	Colwyn*	1370mm (54")	1170mm	1370mm	400mm	25mm	As standard	16"	BV	D
22	Vitalia	1320mm (52")	1035mm	1320mm	400mm	75mm	As standard	16" or 22"	SL	D

* Also available as a surround only (no back panel or hearth)

Micro Marble Gas Fireplaces

Page	Model	Mantel Width	Height	Hearth Width	Hearth Depth	Hearth	Finish	EEC	Efficiency
25	Adele	1370mm (54")	875mm	1370mm	300mm	SL	B	E	74.7%
29	Cassius	1320mm (52")	967mm	1320mm	400mm	SL	B, C	E	75.3%
31	Earlston	1220mm (48")	897mm	1220mm	400mm	SL	A, B	E	75.3%
27	Embleton	1320mm (52")	1159mm	1320mm	400mm	SL	A, B, C	D	83%
30	Mariella	1220mm (48")	1089mm	1220mm	400mm	BV	A, B	D	83%
30	Orieta	1220mm (48")	1089mm	1220mm	400mm	BV	A, B	D	83%
26	Vitalia	1220mm (48")	1080mm	1220mm	400mm	SL	A, B	D	83%
26	Vitalia	1320mm (52")	1150mm	1320mm	400mm	SL	A, B	D	83%
28	Wayland	1320mm (52")	947mm	1320mm	400mm	SL	A, B	E	75.3%

Micro Marble Electric Fireplaces

Page	Model	Mantel Width	Height	Hearth Width	Hearth Depth	Hearth Option	Finishes	22" Switch
35	Alesso	1220mm (48")	1000mm	1220mm	400mm	SL	A, B	✗
38	Amorina	1270mm (50")	1040mm	1270mm	300mm	SL	A, B	✓
33	Cabrina	1320mm (52")	1040mm	1320mm	400mm	SL	A, B	✗
36	Cassius	1320mm (52")	967mm	1320mm	400mm	SL	B, C	✗
43	Cotsmore	1170mm (46")	960mm	1170mm	400mm	SL	A, B	✓
39	Embleton	1320mm (52")	1159mm	1320mm	400mm	SL	A, B, C	✗
41	Farnham	1120mm (44")	930mm	1120mm	240mm / 400mm	BV	A, B	✓
41	Farnham	1220mm (48")	965mm	1220mm	240mm / 400mm	BV	A, B	✓
34	Vistus	1220mm (48")	830mm	1220mm	400mm	SL	A, B	✗
37	Vitalia	1220mm (48")	1080mm	1220mm	400mm	SL	A, B	✗
37	Vitalia	1320mm (52")	1150mm	1320mm	400mm	SL	A, B	✗
38	Wayland	1320mm (52")	947mm	1320mm	400mm	SL	A, B	✗
40	Wellsford	1320mm (52")	855mm	1320mm	300mm	SL	A, B	✗
42	Willaston	1320mm (52")	1159mm	1320mm	400mm	SL	B, C	✓

Timber Electric Fireplaces

Page	Model	Mantel Width	Height	Hearth Width	Hearth Depth	Hearth Option	Finishes	22" Switch
45	Amorina	1270mm (50")	1016mm	1270mm	300mm	SL	E, G	✗
47	Arana	1270mm (50")	1021mm	1270mm	350mm	SL	K	✗
51	Bracken	1170mm (46")	990mm	1170mm	380mm	BN	F, H (+L)	✗
50	Edwin	1320mm (52")	936mm	1320mm	280mm	BV	J	✗
48	Lavina	1270mm (50")	851mm	1270mm	350mm	SL	K	✗
46	Velino	1320mm (52")	1091mm	1320mm	350mm	SL	K	✗
49	Wellsford	1320mm (52")	875mm	1320mm	300mm	BV	G, H	✗

Inset Gas Fires: Exclusive, Devotion & Classic Collections

Page	Model	Width	Height	Inset Depth	Inset Width	Inset Height	EEC
56	Slimline Radiant	510mm	605mm	123mm	352mm	553mm	F
56	Deepline Radiant	510mm	605mm	173mm	403mm	553mm	F
56	Deepline Convector	510mm	605mm	198mm	403mm	553mm	F
56	Mid-Depth High Efficiency	510mm	605mm	128mm	403mm	553mm	D
56	Deepline High Efficiency	510mm	605mm	198mm	403mm	553mm	C
56	Balanced flue*	510mm	605mm	186mm	400mm	550mm	C

* Includes balanced flue kit

See pages 56-57 for finishes

Inset Gas Fires: Chollerton Gas

Page	Model	Width	Height	Inset Depth	Inset Width	Inset Height	EEC
59	16" Chollerton	512mm	611mm	197mm	403mm	555mm	C
60	22" Chollerton	612mm	611mm	195mm	560mm	556mm	C

Inset Gas Fires: Cast Stove Front

Page	Model	Width	Height	Inset Depth	Inset Width	Inset Height
58	16" Mid-Depth High Efficiency	562mm	659mm	128mm	403mm	553mm
58	16" Deepline High Efficiency	562mm	659mm	198mm	403mm	553mm
58	16" Balanced flue	562mm	659mm	186mm	400mm	550mm
59	16" Chollerton	562mm	659mm	197mm	403mm	555mm
61	22" Chollerton	668mm	672mm	195mm	560mm	556mm

Inset Gas Fires: Eclipsim Cast Fascia

Page	Model	Width	Height	Inset Depth	Inset Width	Inset Height
58	Slimline Radiant	563mm	716mm	123mm	352mm	553mm
58	Deepline Radiant	563mm	716mm	173mm	403mm	553mm
58	Mid-Depth High Efficiency	563mm	716mm	128mm	403mm	553mm
58	Deepline High Efficiency	563mm	716mm	198mm	403mm	553mm
58	Balanced flue	563mm	716mm	186mm	400mm	550mm

Wall Mounted Inset Gas Fire

Page	Model	Width	Height	Depth	Inset Depth	Finish	EEC
62-63	Calleos 800CF - Slim Trim	798mm	415mm	280mm	278mm	Matt Black	E
62-63	Calleos 800CF - Wide Trim	857mm	474mm	280mm	278mm	Matt Black	E

Wall Mounted Inset Balanced Flue Gas Fire

Page	Model	Width	Height	Depth	Inset Depth	Finish	EEC
64-65	Elsie 960 BF	1198mm	666mm	187mm	174mm	Brushed Steel Trim	C

Inset Electric Fires

Page	Model	Trim	Width	Height	Inset Depth	Finish	22" Switch
74	16" Chollerton	Chollerton	512mm	611mm	140mm / 75mm*	Chrome or Black Nickel	✗
74	16" Chollerton Edge	Edge	511mm	611mm	140mm / 75mm*	Chrome or Black Nickel	✗
70-71	16" Pryzm	Chollerton	512mm	611mm	140mm / 75mm*	Chrome or Black Nickel	✗
		Edge	511mm	611mm	140mm / 75mm*	Chrome or Black Nickel	✗
		Devotion	510mm	605mm	140mm / 75mm*	Brass, Brushed Steel, Chrome, Blk Nickel	✗
		Devotion + Belmont	510mm	605mm	140mm / 75mm*	Brass, Brushed Steel, Chrome, Blk Nickel	✗
		Devotion + Hampden	510mm	605mm	140mm / 75mm*	Brass, Brushed Steel, Chrome, Blk Nickel	✗
		Devotion + Brantley	510mm	605mm	140mm / 75mm*	Brass, Brushed Steel, Chrome, Blk Nickel	✗
72-73	22"-16" Chollerton**	Chollerton	612mm	611mm	140mm / 75mm*	Chrome or Black Nickel	✓
		Edge	611mm	611mm	140mm / 75mm*	Chrome or Black Nickel	✓
		Cast Stove Front	668mm	672mm	140mm	Matt Black	✓
68-69	22" Pryzm	Chollerton	612mm	611mm	140mm / 75mm*	Chrome or Black Nickel	✓
		Edge	611mm	611mm	140mm / 75mm*	Chrome or Black Nickel	✓
67	22" Pryzm	Cast Stove Front	668mm	672mm	140mm	Matt Black	✓

* 75mm achieved when used with Spacer frame

** Spacer required for 16" back panel cut out

Inset Electric Stoves

Page	Model	Width	Height	Depth	Inset Depth	Finish
75	Desire	486mm	587mm	238mm	69mm	Matt Black
75	Ora	506mm	597mm	249mm	69mm	Matt Black
75	Ignite	486mm	587mm	236mm	69mm	Matt Black
77	Beacon Small	486mm	599mm	232mm	45mm	Matt Black
77	Beacon Large	586mm	599mm	232mm	45mm	Matt Black

Freestanding Electric Stoves

Page	Model	Width	Height	Depth	Finish
76	Beacon Large	586mm	599mm	292mm	Matt Black or Ash White
76	Beacon Small	486mm	599mm	292mm	Matt Black or Ash White



Calleos 800CF gas fire

Finishes & Dimensions



Hearth Options



Slim hearths are 240mm deep, deep hearths are 400mm, unless otherwise stated.



BESPOKE SIZES. Ask your local retailer for more information.

Smartsense Lights



Undermantel Smartsense lighting is available on many of our surrounds.

Watch the Video

Scan the QR code below with your mobile phone camera to view our latest product videos.



Find your local retailer

Once you have chosen your favourite surround, picked the finest fire and measured up to ensure it will fit, it's time to visit your local showroom.

Admiring these British designed and manufactured fireplaces first hand is the best way to understand their quality and craftsmanship. Why not take paint charts, fabric samples or photos of your room to match with the surrounds.

If you need advice, you can trust the experience of our independent retailers.

To find your local retailer visit our website or call us.

elginandhall.co.uk
0191 430 9434



ARTEON

NEW BROCHURE - IN STORE OR DOWNLOAD ONLINE



P R  Z M

REVOLUTIONIZING FLAMES

www.elginandhall.co.uk/collection/pryzm

bemodern®

For more information on our other brands,
please contact them below.



ELGIN & HALL®
BRITISH MADE

www.elginandhall.co.uk
tel: 0191 430 9434

P R Y Z M
REVOLUTIONIZING FLAMES

www.elginandhall.co.uk/collection/pryzm
tel: 0191 430 9434

BROSELEY

www.broseleyfires.com
tel: 0191 489 8006

evolution
by **BROSELEY**

www.broseleyfires.com
tel: 0191 489 8006

atlanta®
Bathrooms

atlantabathrooms.com
tel: 0191 428 0444



ELGIN & HALL®

BRITISH MADE



Contact Us

For more information or to place an order please contact us

Tel: 0191 430 9434 | Email: enquiries@elginandhall.co.uk | Visit: www.elginandhall.co.uk

BeModern® | 19/34 Bedesway | Bede Industrial Estate | Jarrow | Tyne and Wear | NE32 3BE

BeModern® hold design copyright and registration of design for its product ranges. BeModern® are continually striving to improve and develop their range of products. It is important, therefore, to check details before ordering as sizes and specifications may change without prior notice. Whilst every effort is made to ensure accuracy and colour, it is not always possible to obtain perfect reproduction because of the materials and printing processes used and you may find that shades, natural grain markings and marble colouring are not consistent. © BeModern® March 2021

Front cover: Odella Inglenook in White Micro Marble with Heslington electric stove by Evolution.

